



Safe and Secure Integration of Automation Systems and Enterprise IT Infrastructure Using Cloud

Nary Subramanian, University of Texas at Tyler
Janusz Zalewski, Florida Gulf Coast University
with Steven Drager and William McKeever, AFRL/RITA

DISTRIBUTION STATEMENT A. Approved for public release; distribution is unlimited.
PA Approval: #88ABW-2012-2050 dated: 05 April 2012

FGCU



Instead of a Talk Outline

Essentially about 2 things:

- Integration of Automation & Enterprise IT in the Cloud
- How do Safety and Security play in it?



Typical Automation System (SCADA) Architecture

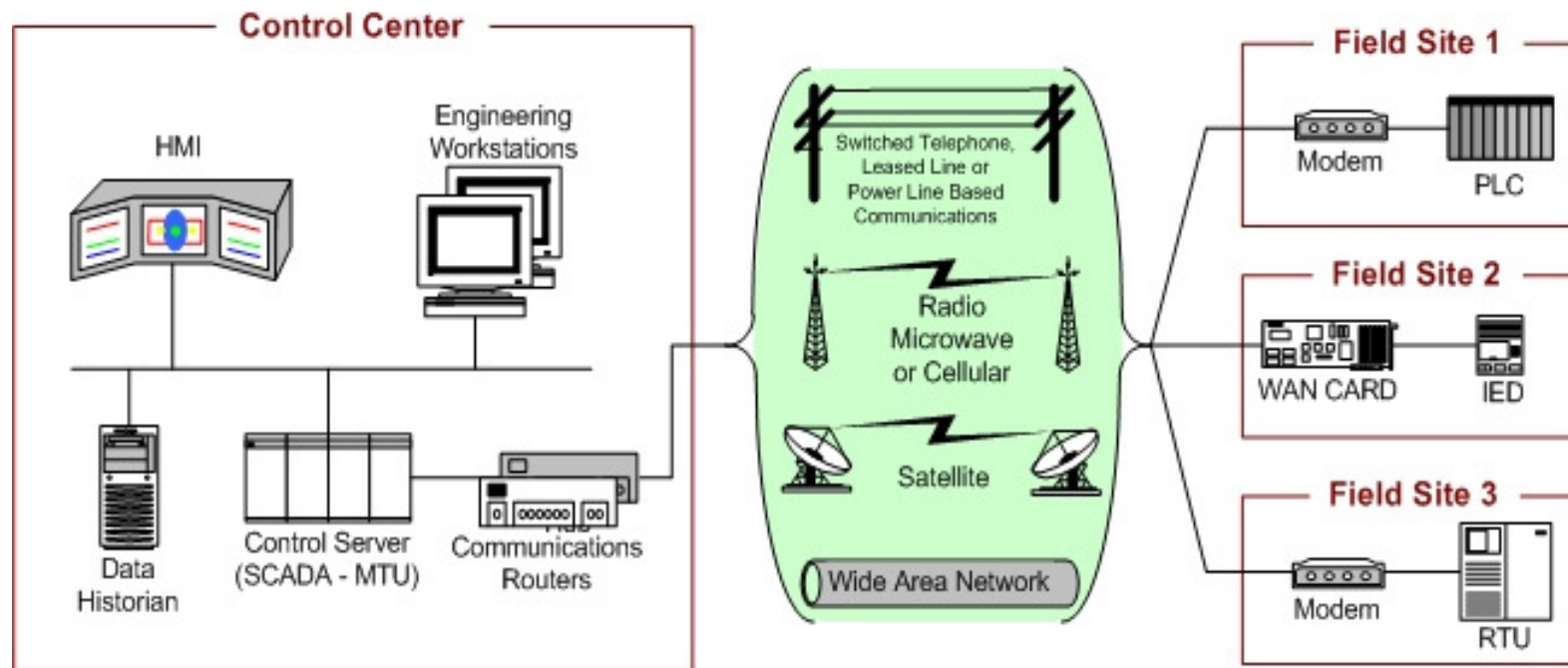

Source: NIST SP 800-82, June 2011



Typical Enterprise IT Architecture

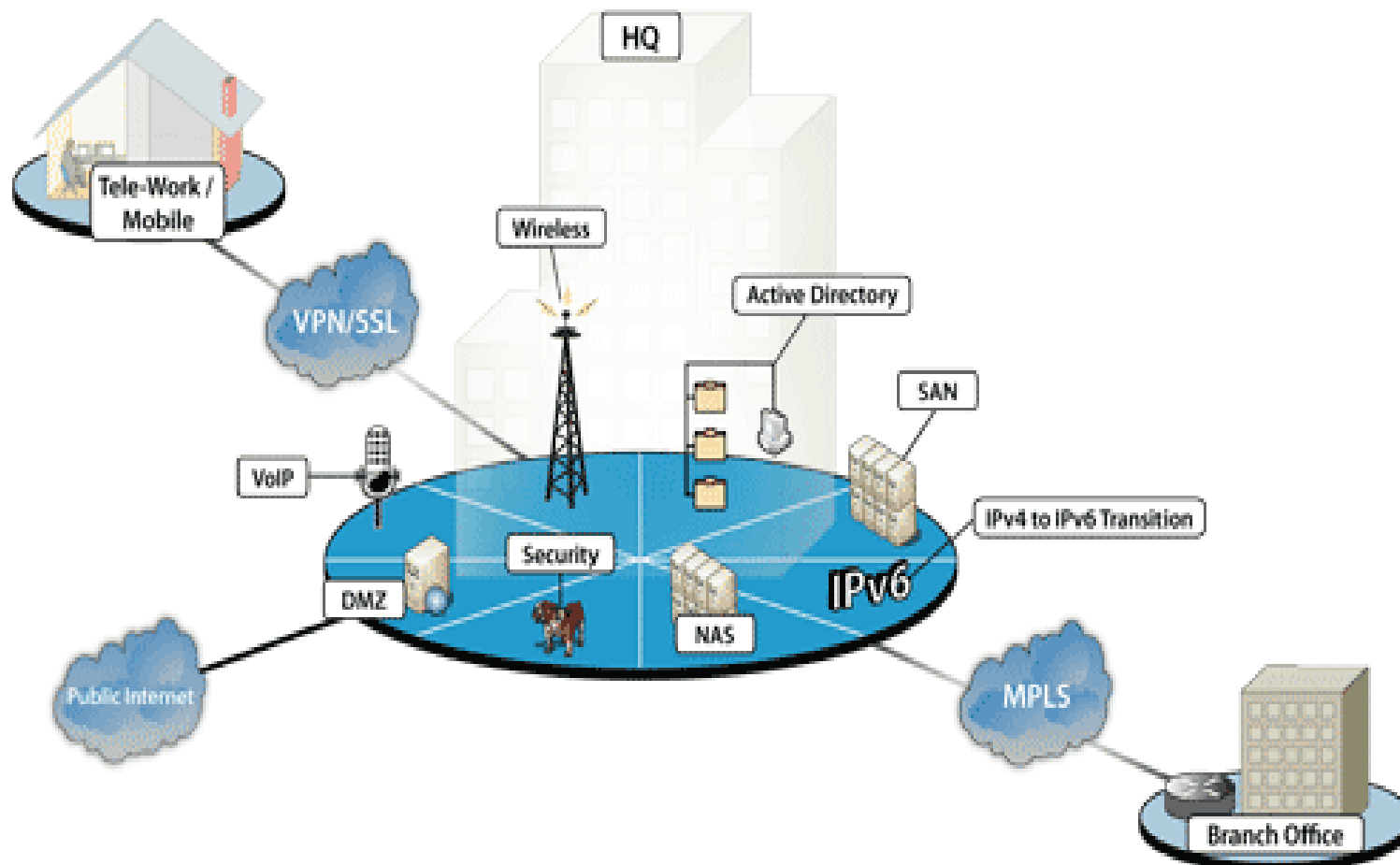

Source: www.caci.com/fcc/eit.shtml

FGCU



Problems with Separate SCADA and IT Infrastructure

- IT system maintained by corporate IT
- Typically CS/CIS/IT/MIS graduates
- SCADA system maintained by process control engineers
- Typically EE/ME/ChE graduates
- Two separate maintenance hierarchies
- SCADA engineers not very familiar with IT problems and vice versa



Similarities Between SCADA and IT Systems

- Both are monitored 24x7x365
- Both have availability, reliability, safety, and security requirements
- Both have distributed nature
- Both have centralized hubs: servers in the case of IT and master terminal unit in the case of SCADA
- and ...



Similarities Between SCADA and IT Systems

- Both are monitored 24x7x365
- Both have availability, reliability, safety, and security requirements
- Both have distributed nature
- Both have centralized hubs: servers in the case of IT and master terminal unit in the case of SCADA
- Both can be integrated to run in the cloud



Integrating IT & SCADA using Cloud

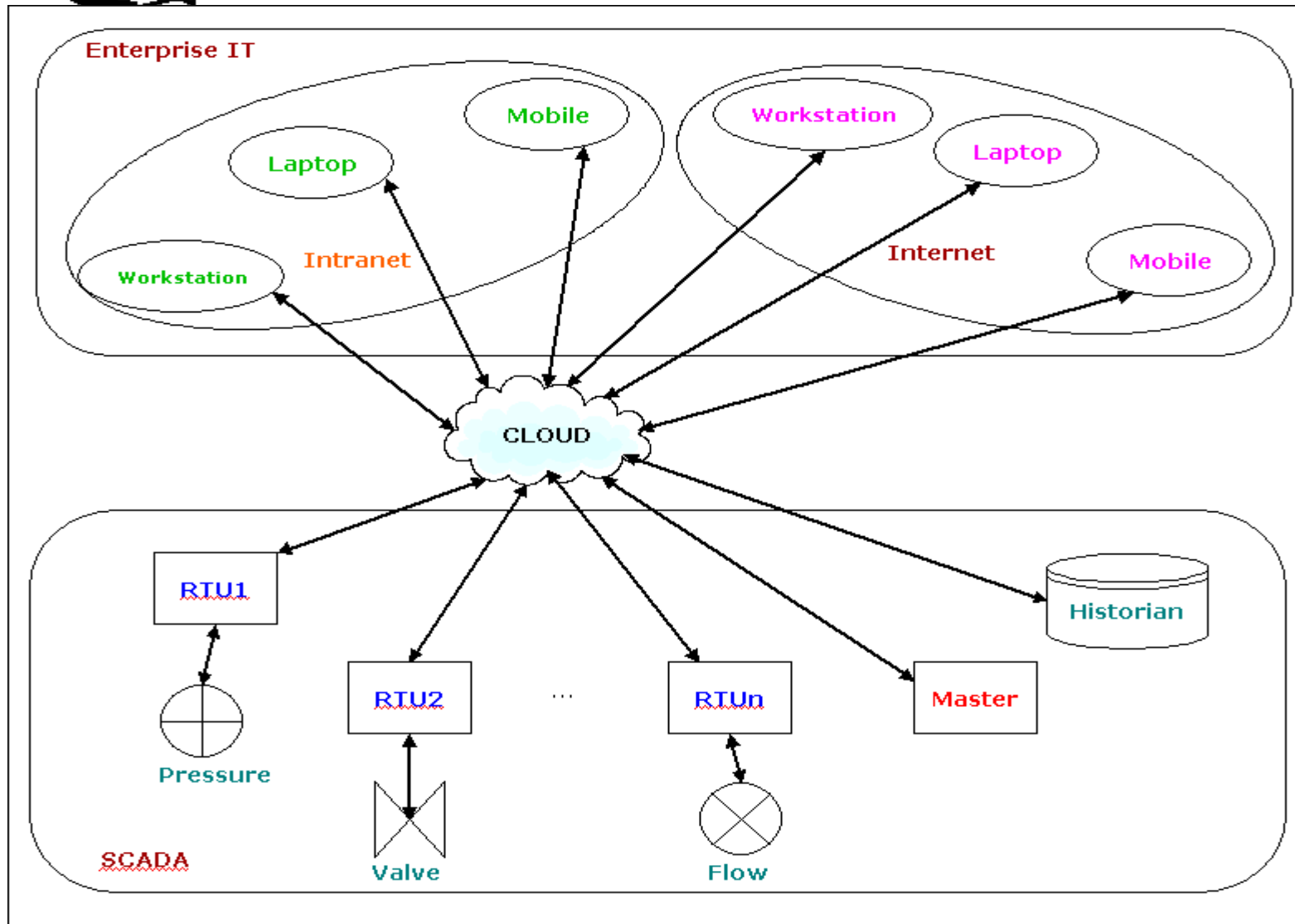



Integrated Cloud-based Infrastructure

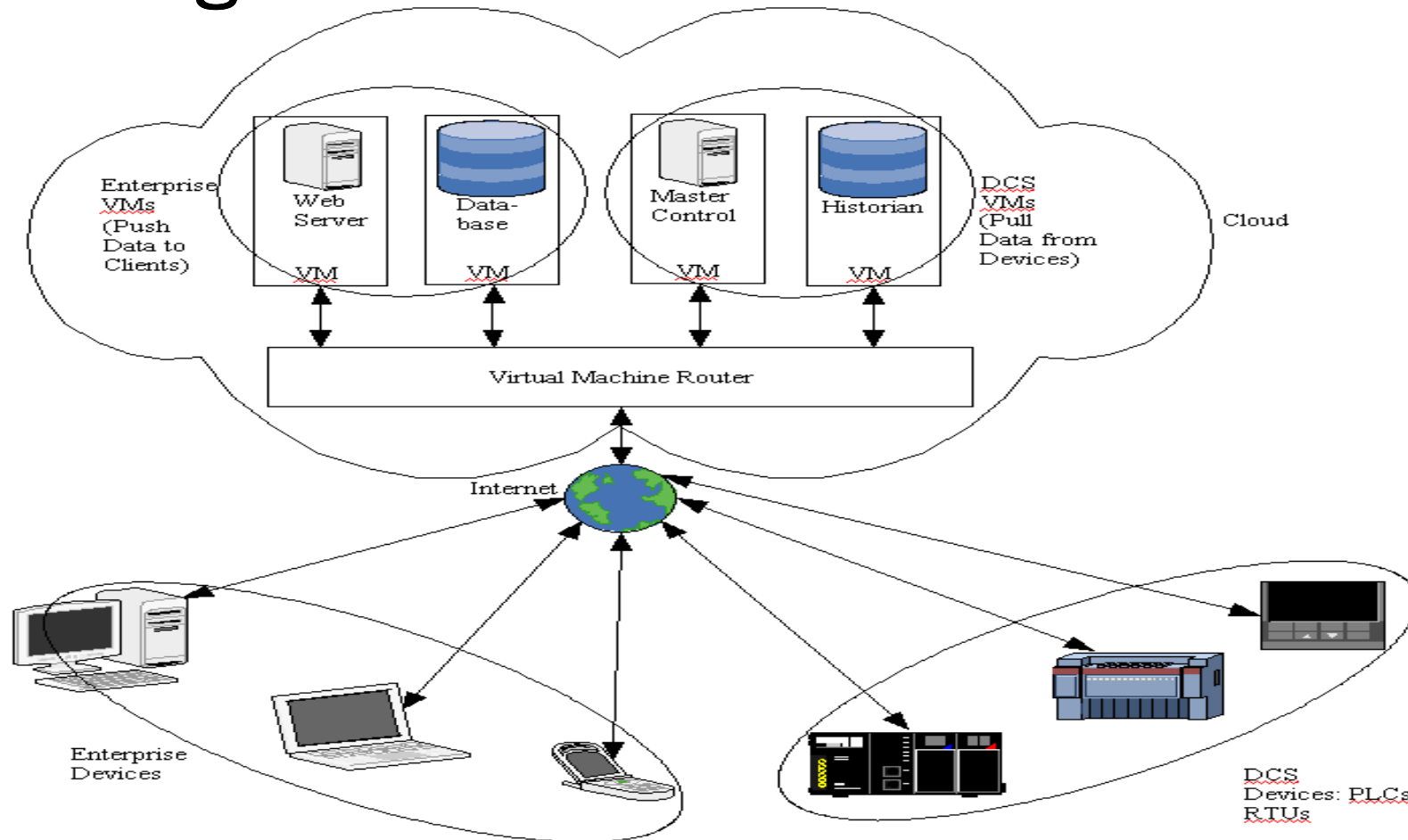



Integrated Architecture Advantages

- All operations handled through cloud service provider
- SCADA components and IT components integrated through the cloud
- IT components need middleware (running in cloud data center) to link them to the correct servers
- SCADA components need middleware (running in cloud data center) to link them to the correct master and historian
- Security becomes more affordable for the organization for both IT and SCADA infrastructure
- IT and SCADA can be interlinked in the cloud improving security of inter-system access
- Provides for better management of both IT and SCADA systems



When do you use Cloud?

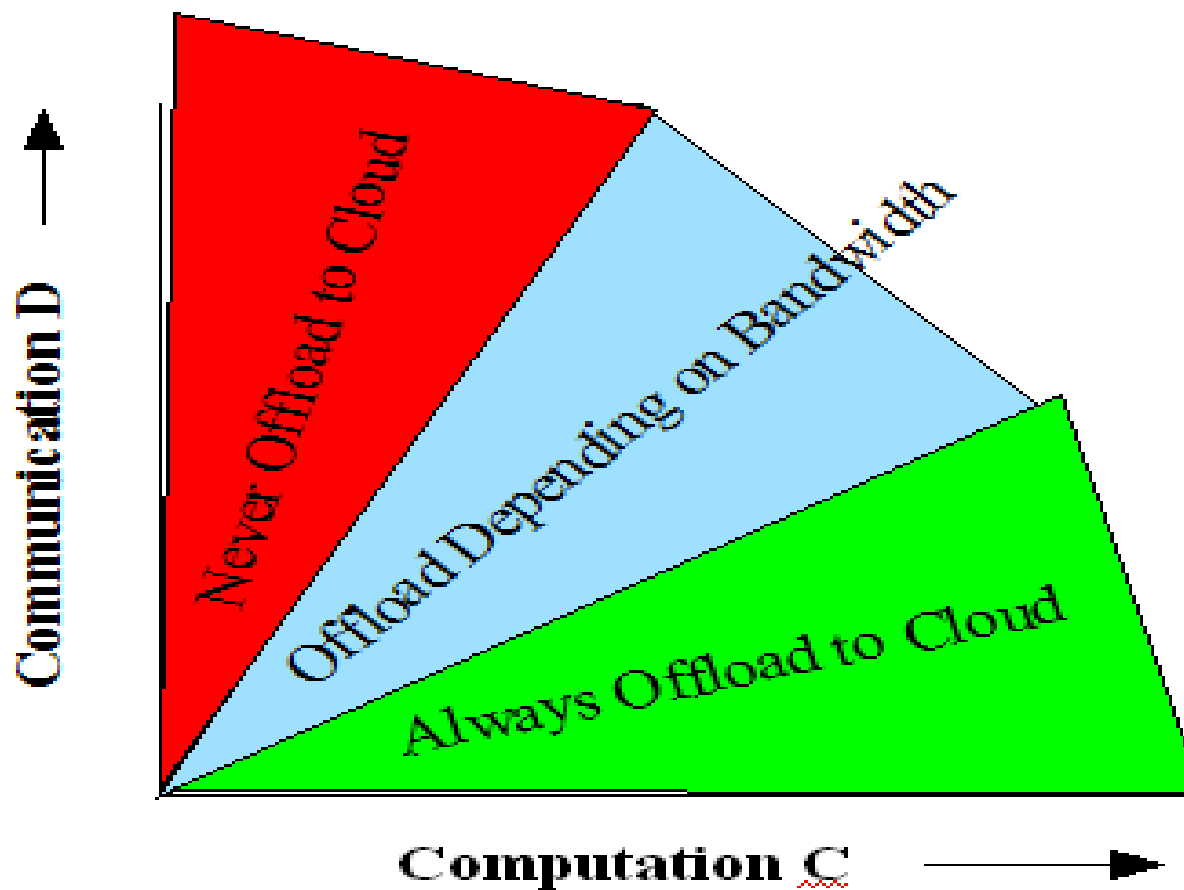

Source: "Cloud Computing for Mobile Users: Can Offloading Computation Save Energy", K. Kumar and Y-H Lu, IEEE Computer, April 2010, pp. 51 - 56.



Where is SCADA?

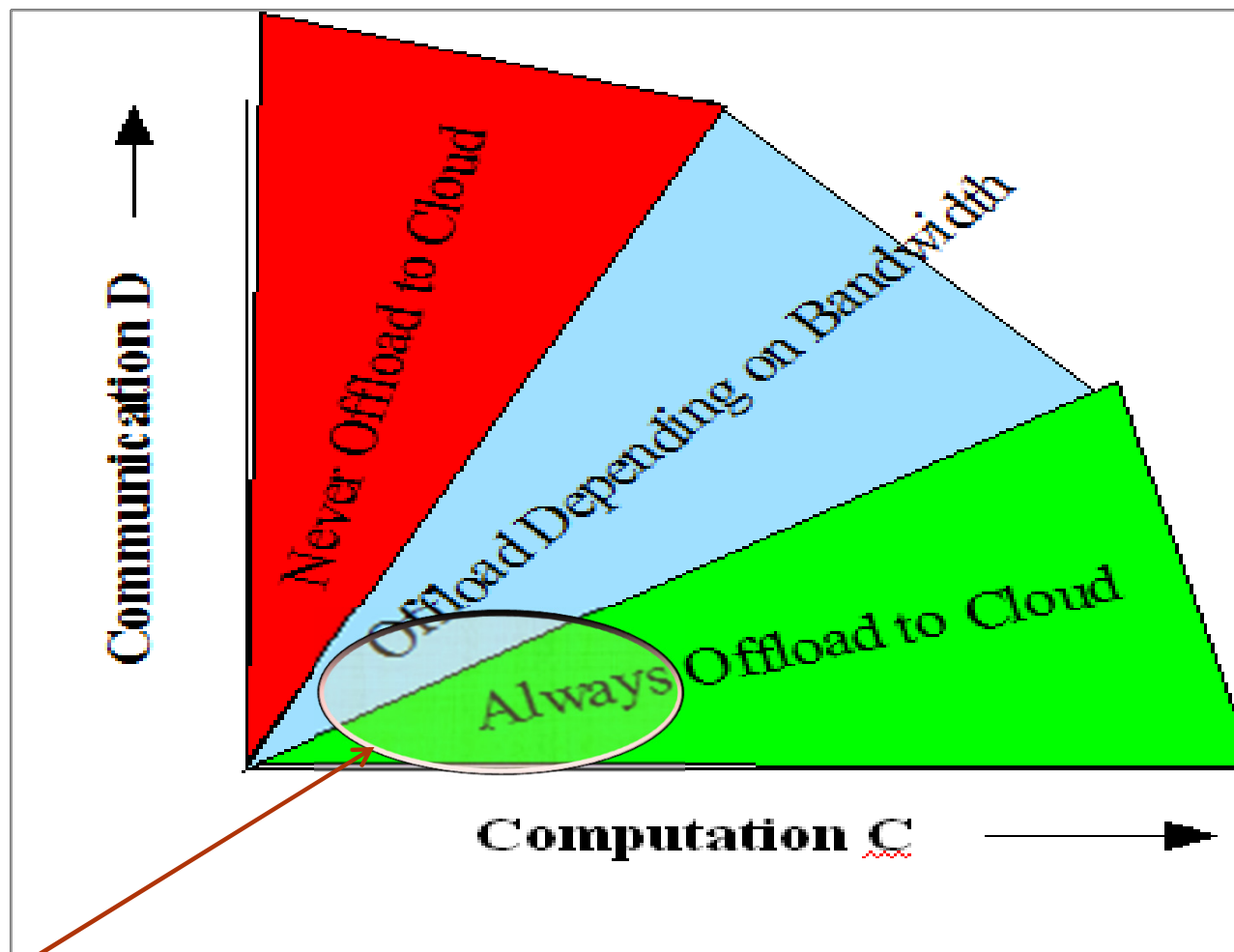

SCADA is in this region



Critical System Properties:

- Safety
- Security
- Reliability
- Availability
- others

Can they be transferred to the Cloud?



Transferring Safety and Security to the Cloud

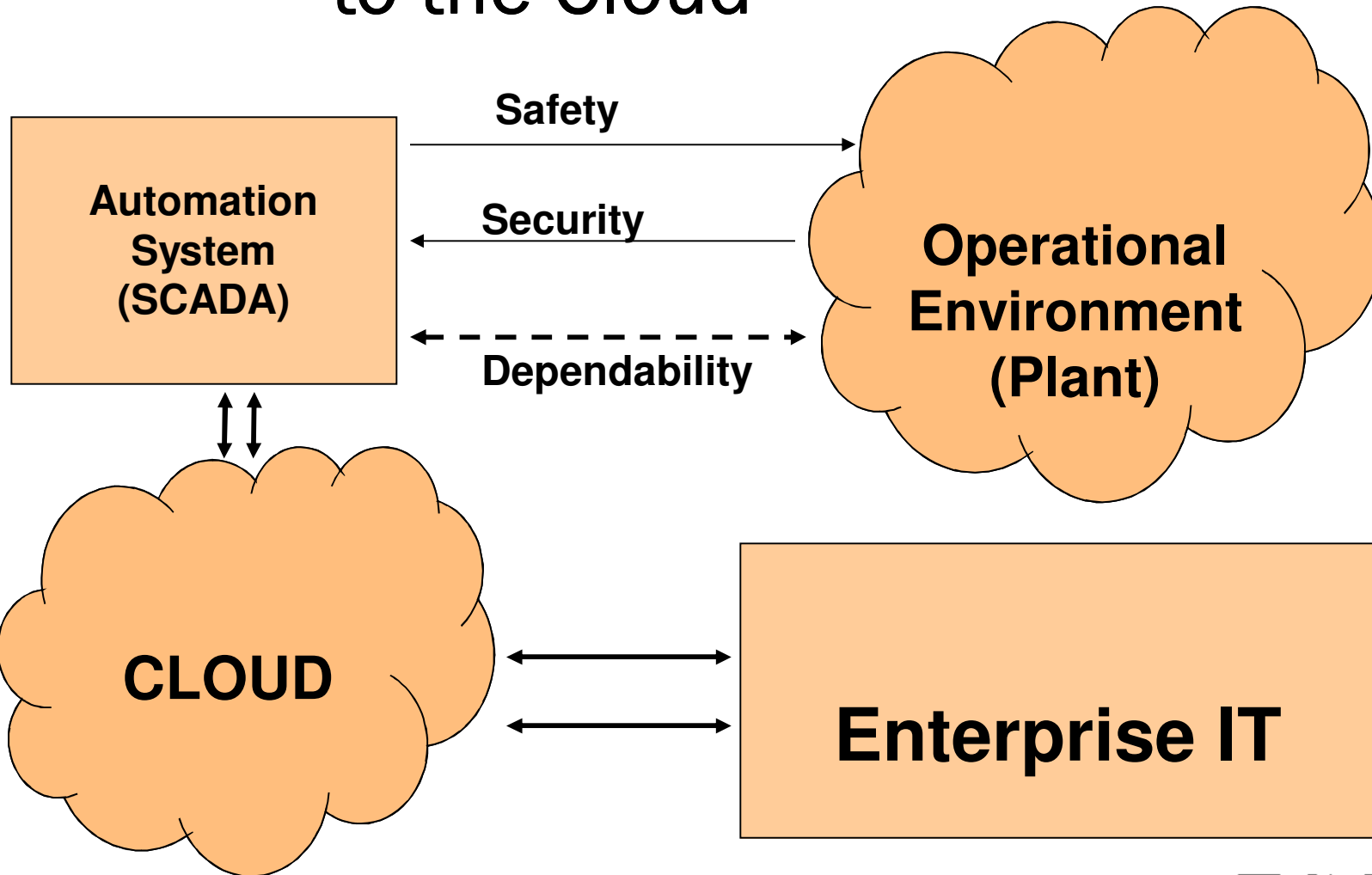



Safety vs. Security: General View

- Safety is concerned when a technical or social system negatively affects the environment
Latest example: Fukushima Nuclear Power Plant
- Security ...



Safety vs. Security: General View

- Safety is concerned when a technical or social system negatively affects the environment
Latest example: Fukushima Nuclear Power Plant
- Security is concerned when an Environment negatively affects the technical or social system
Latest example: Wikileaks release of classified information



Safety vs. Security: General View

- Safety is concerned when a technical or social system negatively affects the environment
Latest example: Fukushima Nuclear Power Plant
- Security is concerned when an Environment negatively affects the technical or social system
Latest example: wiki leaks release of classified information
- In both cases, the system must continue functioning
- In both cases, safety and security affect each other



Safety vs. Security: General View

- Safety and Security are negative properties

This means that there are generally not measurable, since there are no computable functions that would map respective properties onto a number set

- Thus ...



Safety vs. Security: General View

- Safety and Security are negative properties
This means that there are generally not measurable, since there are no computable functions that would map respective properties onto a number set
- The only practical way to evaluate Safety and Security is modeling:
 - modeling hazards for Safety assessment, and
 - modeling threats for Security assessment.



Example of a Modeling Architecture

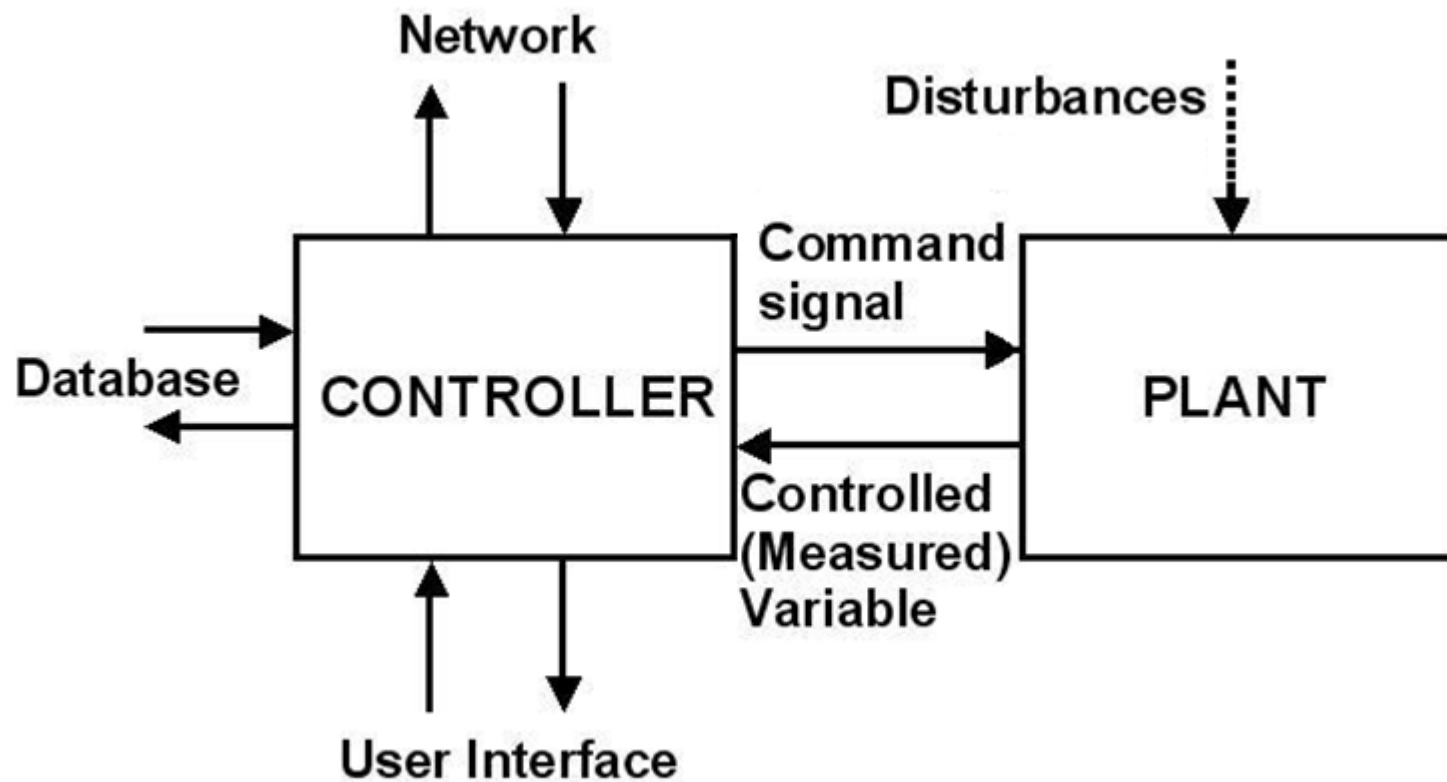



Example of a Modeling Architecture

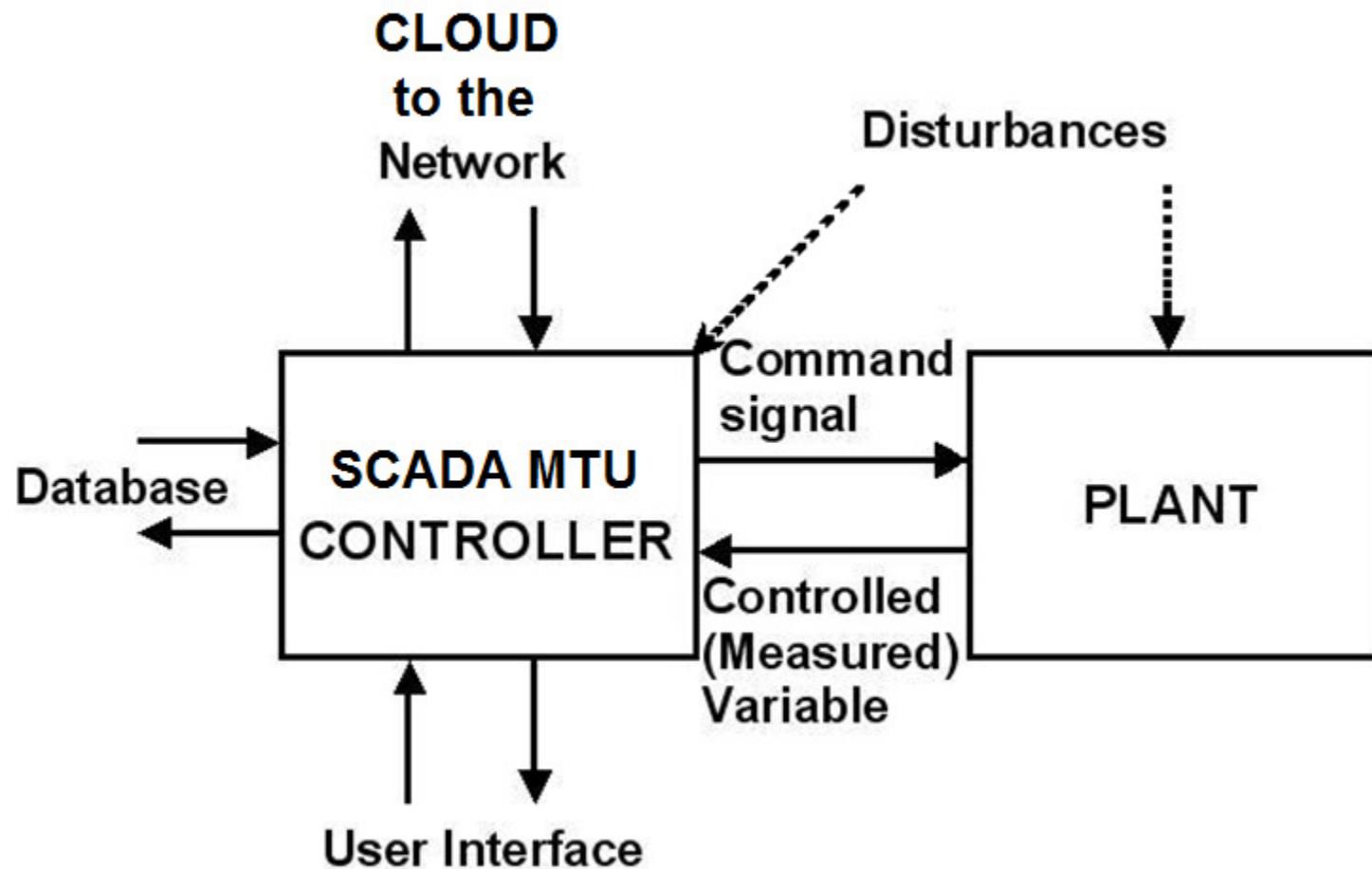



Example of a Modeling Architecture

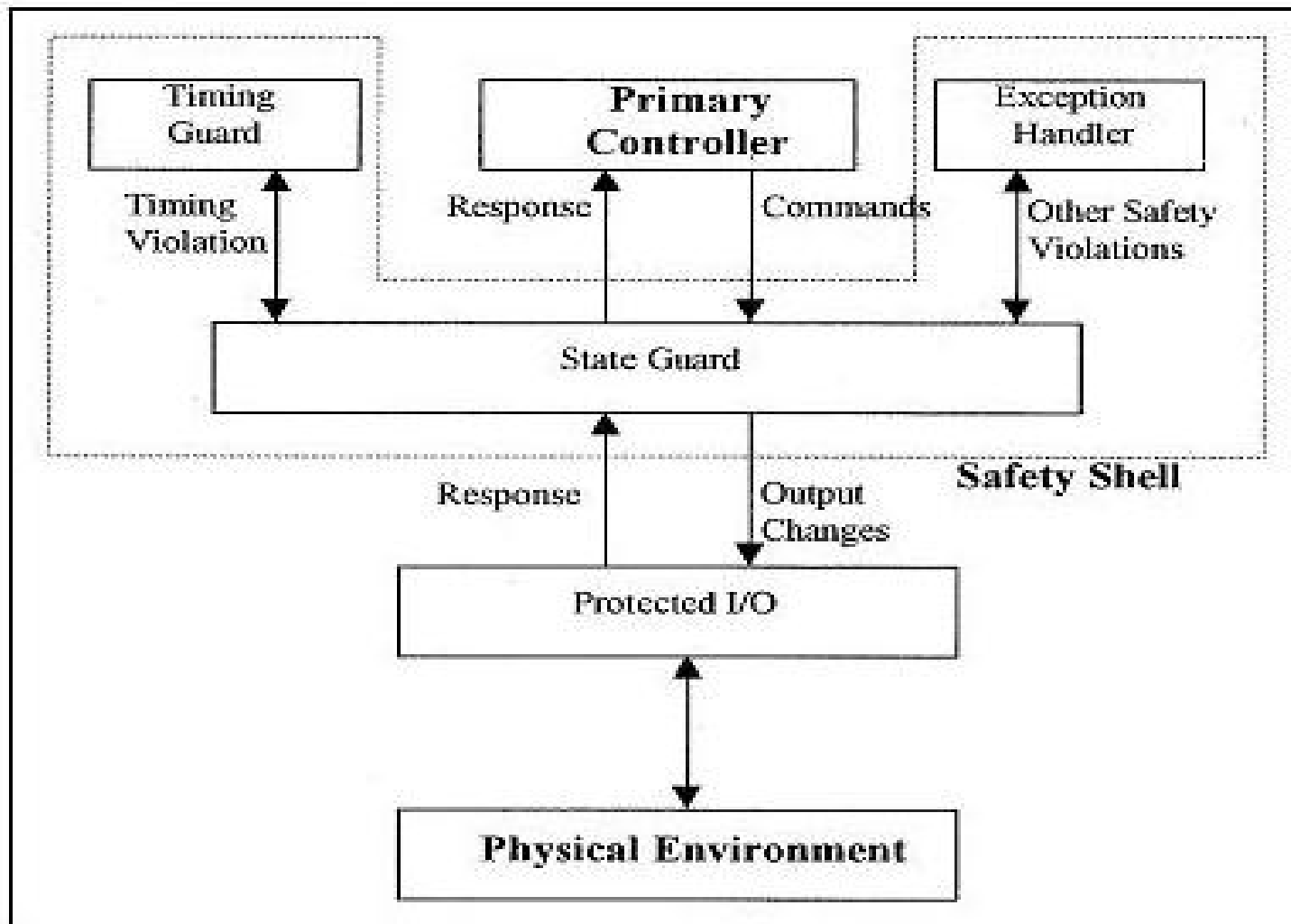



Example of Modeling Security

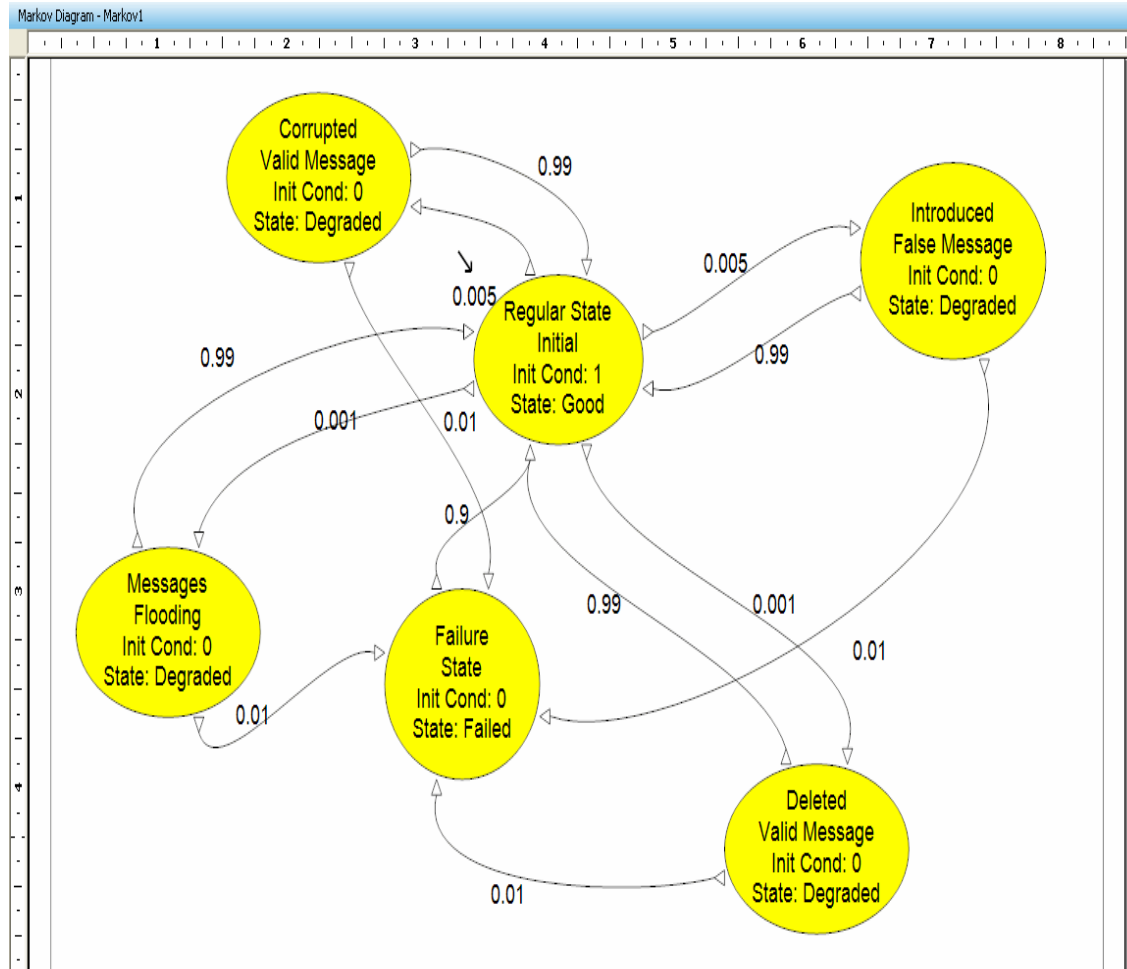

Source: "Availability Assessment of Embedded Systems with Security Vulnerabilities", A. Kornecki and J. Zalewski, 34th IEEE Software Engineering Workshop, Limerick, 2011



Conclusion

There are multiple advantages of an integrated architecture

- Essential operations handle through cloud service provider
- IT and SCADA can be interlinked and integrated
- Better management of SCADA and IT systems

However ...



Conclusion

There are multiple advantages of an integrated architecture

- Essential operations handle through cloud service provider
- IT and SCADA can be interlinked and integrated
- Better management of SCADA and IT systems

Transferring Safety and Security to the Cloud requires attention

- A cloud-based system should not affect the overall computing system safety – should professional management take care of data centers and associated hardware and software?
- A cloud-based system makes the overall computing system secure – should professionals take care of security issues at a central location?
- Enterprise IT and process control system divisions can focus on their core missions